

# DENON®

## DHT-S516H

Wireless Sound Bar and Subwoofer System

## Quick Start Guide



# BEFORE YOU BEGIN

The Denon DHT-S516H is designed to enhance the sound of your TV and allow you to enjoy HEOS Wireless Multi-Room Sound.

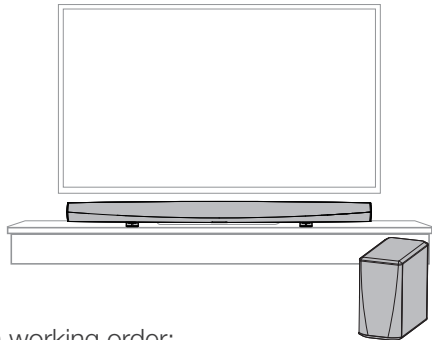

Make sure you have the following items in working order:

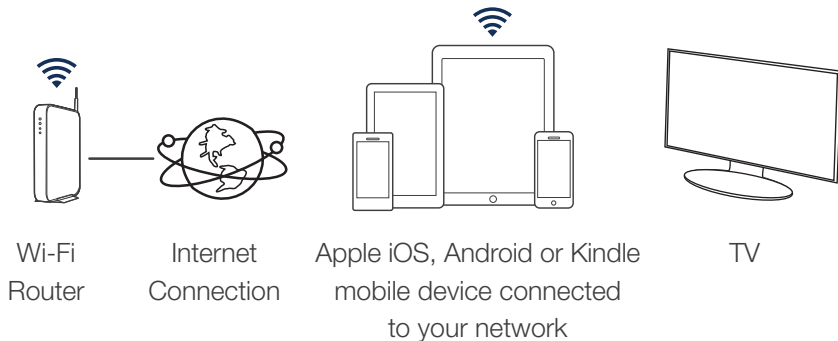

# STEP 1: UNPACK

Carefully unpack your DHT-S516H.

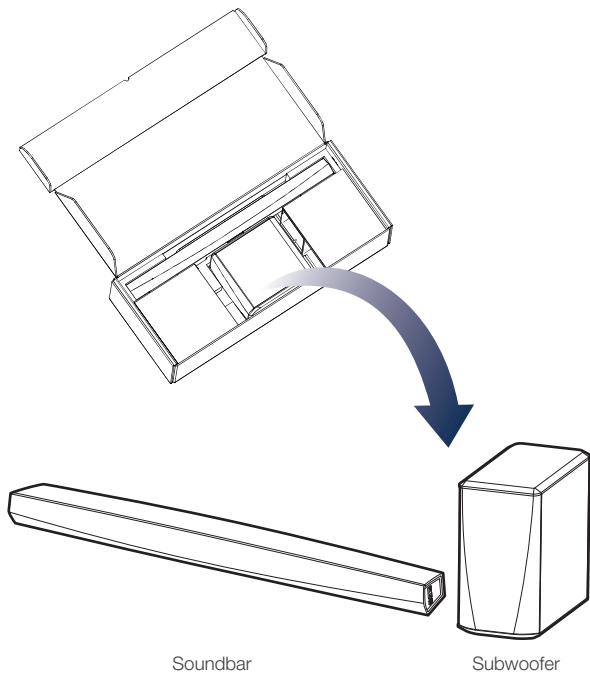

# STEP 1: UNPACK

Verify that the following items are included in the accessories box.



3.5 mm  
setup cable

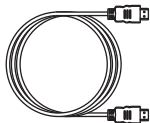

HDMI cable

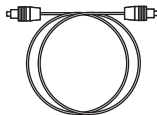

Optical cable



Ethernet cable



IR blaster



Power cords

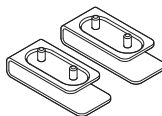

Riser feet



Wall mount bumper  
pads for Soundbar



Non-skid pads  
for Subwoofer

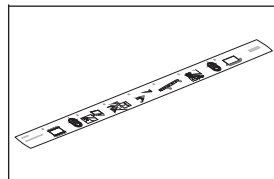

Wall mount template

# STEP 2: PLACE

## PLACING THE SOUNDBAR

Place the DHT-S516H at a convenient location near the TV.

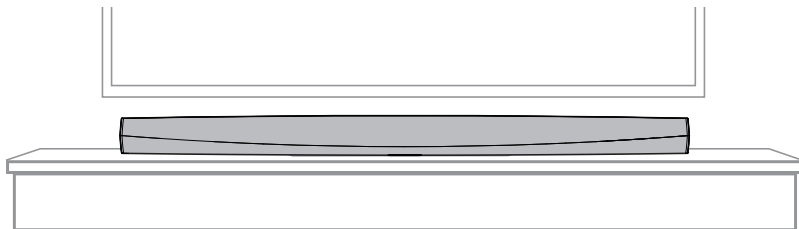

### OPTIONAL

The DHT-S516H Soundbar can be wall-mounted using the integrated keyhole mounts. Please refer to the wall mount template located behind the Soundbar in the product carton.

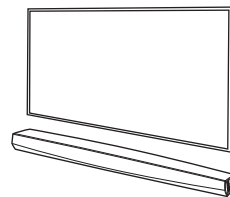

English

Français

Español

Deutsch

Nederlands

Italiano

Svenska

Dansk

Norsk

Pycckий

Polski

Common

# STEP 2: PLACE

## OPTIONAL

Attach the supplied riser feet if you need to raise the Soundbar over your TV stand base.

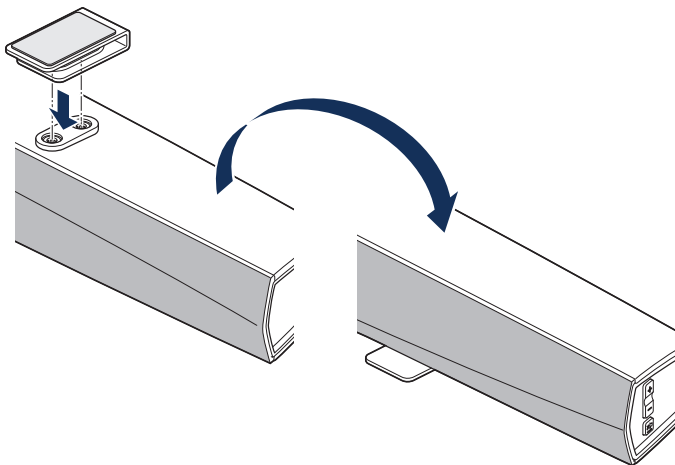

# STEP 2: PLACE

## PLACING THE SUBWOOFER

- 1 Attach the included non-skid pads to the four corners of the Subwoofer's side or bottom if you are placing it on a hard surface.
- 2 Place the Subwoofer in a convenient location on the floor near the Soundbar.

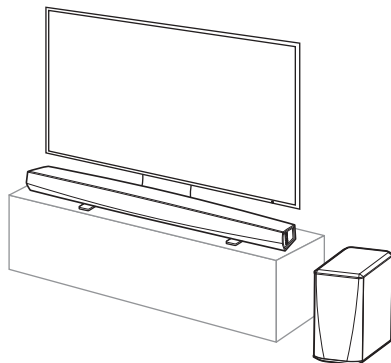
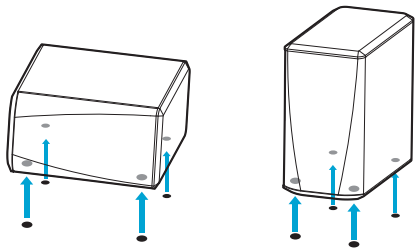

# STEP 3: CONNECT

Connect the power cord between the Soundbar and a wall outlet and the power cord between the Subwoofer and a wall outlet.

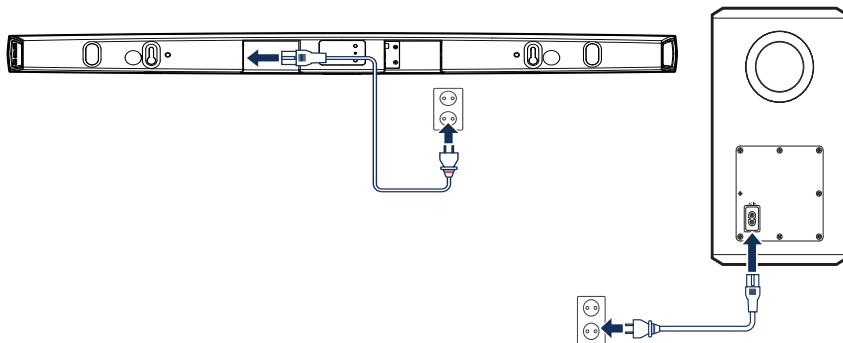

## OPTIONAL

If you are connecting the DHT-S516H to a wired network, connect the included Ethernet cable between the DHT-S516H and your router.

Do not connect the Ethernet cable if you are connecting your DHT-S516H to a wireless network.

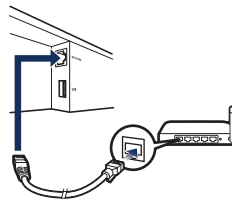



# STEP 3: CONNECT

## OPTIONAL

If you are wall mounting your DHT-S516H you can skip this step.

- 1 Connect the IR blaster to the “IR OUT” jack on the back of the Soundbar.



- 2 Peel off the backing and affix the blaster to the Soundbar so that it directly faces the IR receiver on your TV.

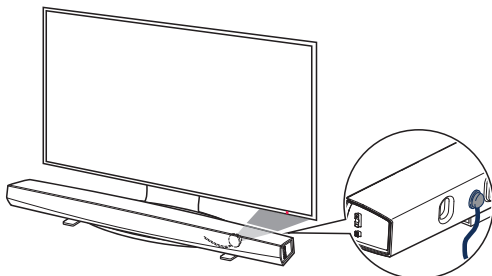

Note: The location of the IR receiver may be different on your TV. Please consult your TV manual.

# STEP 4: CONTROL

- 1 Download the HEOS App  
Go to the Apple App Store, Google Play or Amazon App Store and search for “HEOS” to download and install.



- 2 Launch the HEOS App  
and follow the instructions in the app to complete the setup and configuration of the DHT-S516H.



# STEP 5: ADD DEVICE

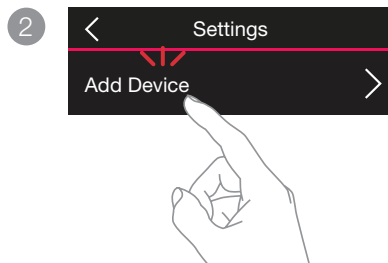
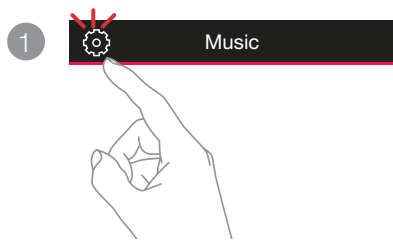

## ENJOY!

### OWNER'S MANUAL

- For more information, visit [www.denon.com](http://www.denon.com)
- Refer to the Online Manual for other functions information and operation procedure details.  
[manuals.denon.com/DHTS516H/EU/EN/](http://manuals.denon.com/DHTS516H/EU/EN/)

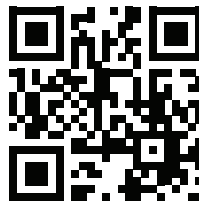

# BASIC TROUBLESHOOTING

## **My HEOS device won't connect to my network using the audio cable**

- Make sure your mobile device is connected to your wireless network before setting up your HEOS device.
- Alternatively, you can connect your HEOS device to your network router using the included Ethernet cable. Once connected via Ethernet, the HEOS by Denon App should recognize the HEOS device and you can manually move it to your wireless network using *Settings/My Devices/Device\_Name/Advanced/Network Settings*.

## **Music cuts out or delays sometimes**

- Make sure your Internet connection is operating correctly.
- If you are sharing your network with other users or devices, they may be using most of your bandwidth (especially if they are streaming video).
- Make sure your HEOS devices are within range of your wireless network.
- Make sure your HEOS devices are not located near other electronic devices that could interfere with its wireless connectivity (like microwave ovens, cordless phones, TVs, etc...).

## **No Subwoofer sound, sound interrupted, or noise occurring**

- Check that the status LED is lit in blue on the Subwoofer. When the Status LED is lit in amber, disconnect from the wall outlet and then reconnect to it, or try to pair again.
  1. Press the Pair Button on the Subwoofer until the Status LED flashes amber rapidly.
  2. Press the Pair Button on the back of the Soundbar. The Status LED on the Subwoofer will be solid blue.
- When there is an obstacle between the Soundbar and the Subwoofer, remove it or place the Subwoofer closer to the Soundbar.

## **Cannot pair a Bluetooth device with the HEOS device**

1. Activate the Bluetooth setting on your mobile device.
2. Press and hold the Bluetooth button (📶) located on the back of the Soundbar for 3 seconds and release the button when you see a pattern of two green flashes on the status LED.
3. Select "Denon DHT-S516H" from the list of available Bluetooth devices.

## Connecting to a network using an iOS device

- This HEOS device supports Apple's "WAC (Wireless Accessory Configuration)" setup mode. WAC setup mode allows you to connect your HEOS device to your network without requiring you to type in the network name and password.
  - The LED on the rear of the HEOS device will slowly blink amber to indicate that WAC setup mode is active. If the rear LED is not blinking amber, press and hold VOLUME DOWN and MUTE buttons for 3 seconds until you see the LED blinking amber.
  - Go to the Wi-Fi menu under Settings on your iOS device.
  - Select "Denon DHT-S516H" under "SET UP NEW AIRPLAY SPEAKER..." at the bottom of the list.
  - Select the network you want your HEOS device to connect to and select "Next".
  - Follow the instructions on the screen to complete setup.
  - When the connection is complete, the LED on the front of the HEOS device will turn solid blue.
- HEOS will stay in WAC setup mode for 15 minutes. If the device is not setup within 15 minutes, it will revert back to its previous network connection. Press the Mute button if you want to cancel WAC setup mode.

## Connecting to a network using WPS

- If your wireless router support WPS (Wi-Fi Protected Setup™) your HEOS wireless device can optionally connect to your network using the "Push Button" method by following these steps:
  - Press the WPS button on your router.
  - Within 2 minutes, Press and Hold the Connect button on the rear panel of the HEOS device for 3 seconds.
  - The LED on the front of the HEOS device will flash green for several seconds as it connects to your router.
  - When the connection is complete, the LED on the front of the HEOS device will turn solid blue.

## Resetting Your Device

- Resetting your HEOS device will clear out the wireless network settings, EQ, and name but retain it's current software. You will have to use Settings->Add Device to reconnect the device to your home network before it can be used.
- To reset your HEOS device, press and hold the Connect and Bluetooth buttons located on the back of the HEOS device for 5 seconds until the front LED begins to flash amber

The HEOS by Denon app and brand is not affiliated with any manufacturer of any mobile device.

HEOS and the HEOS logo are trademarks or registered trademarks in the US and/or other countries.

Apple and the Apple logo are trademarks of Apple Inc., registered in the U.S. and other countries. App Store is a service mark of Apple Inc.

Google Play is a trademark of Google Inc.

Amazon, Kindle, Echo, Alexa, Dash, Fire and all related logos are trademarks of Amazon.com, Inc. or its affiliates.

Wi-Fi Protected Setup™ logo is trademark of Wi-Fi Alliance.

The Bluetooth® word mark and logos are registered trademarks owned by the Bluetooth SIG, Inc. and any use of such marks by D&M Holdings Inc. is under license. Other trademarks and trade names are those of their respective owners.

All other trademarks are the property of their respective owners.

# CONTACT Denon

 00800-43674357

**EN**

## FREE HELPLINE

We hope you will enjoy your HEOS enabled product for years to come. If you ever have any questions or need any support, just get in touch. We are happy if you are happy.

The free HEOS helpline (English) is currently available in the United Kingdom, Ireland, Sweden, Norway, Denmark and Finland.

For more information visit [www.denon.eu/support](http://www.denon.eu/support)

**ES**

## TELÉFONO GRATUITO DE AYUDA (DISPONIBLE EN ESPAÑA)

Encontrarás las respuestas a las preguntas más frecuentes y más información en [www.denon.eu/support](http://www.denon.eu/support)

**NL**

## GRATIS HULPLIJN

We hopen dat u nog jaren plezier zult hebben van uw met HEOS uitgeruste product. Als u vragen heeft of ondersteuning nodig heeft, neem dan gewoon contact op. Als jij blij bent, zijn wij dat ook.

Hulplijn is beschikbaar in Nederland, België en Luxemburg.

Meer informatie is te vinden op [www.denon.eu/support](http://www.denon.eu/support)

**PL**

## BEZPŁATNA INFOLINIA (DOSTĘPNA W POLSKA)

Odpowiedzi na najczęściej zadawane pytania i bardziej przydatne informacje można znaleźć pod adresem [www.denon.eu/support](http://www.denon.eu/support)

**DE**

## KOSTENFREIER SUPPORT

Wir hoffen, dass Sie mit Ihrem neuen HEOS fähigen Produkt lange Freude haben werden. Falls Sie zu irgendeinem Zeitpunkt Fragen haben oder Unterstützung benötigen, zögern Sie nicht, uns zu kontaktieren.

Die kostenfreie Rufnummer für den deutschsprachigen Support steht Ihnen in Deutschland, Österreich und der Schweiz zur Verfügung.

Weitere Informationen erhalten Sie unter [www.denon.eu/support](http://www.denon.eu/support)

## OTHER REGIONS / AUTRES PAYS

For support options in other countries than those mentioned above, please visit [www.denon.eu](http://www.denon.eu) and choose your country.

Pour connaître les options de support dans d'autres pays, par avance merci de vous connecter dans notre site [www.denon.eu](http://www.denon.eu) puis sélectionner votre pays.

English

Français

Español

Deutsch

Nederlands

Italiano

Svenska

Dansk

Norsk

Pycckий

Polski

**Common**

**DENON<sup>®</sup>**

**[www.denon.com](http://www.denon.com)**

Printed in China 5411 11771 00AD  
Copyright ©2019 D&M Holdings Inc. All Rights Reserved.